

# FLUIDMASTER®

## CABLE DUAL FLUSH VALVE INSTALLATION

### INSTRUCTIONS FOR TOILET CISTERN WITH LEVER ACTIVATION

TO GET THE BEST RESULTS FROM YOUR FLUIDMASTER VALVE, PLEASE READ THESE INSTRUCTIONS CAREFULLY.

**NOTE:** SAVE INSTRUCTION SHEET FOR FUTURE REFERENCE CONCERNING THIS VALVES OPERATION & MAINTENANCE.

#### PARTS LIST

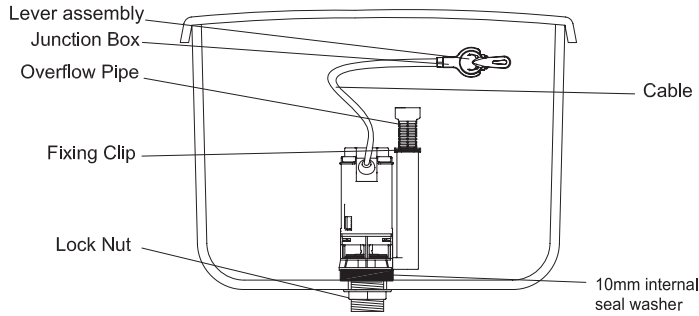

Unlock the Fixing Clip to adjust the Overflow Pipe to desired height, then lock the Fixing Clip.

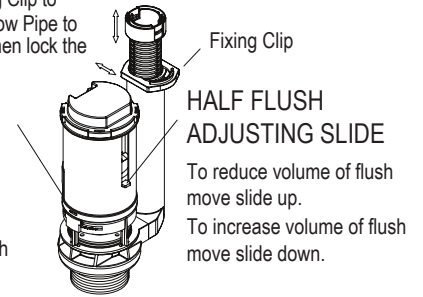

#### FULL FLUSH ADJUSTING SLIDE

To reduce volume of flush move slide up.  
To increase volume of flush move slide down.

#### HALF FLUSH ADJUSTING SLIDE

To reduce volume of flush move slide up.  
To increase volume of flush move slide down.

1.

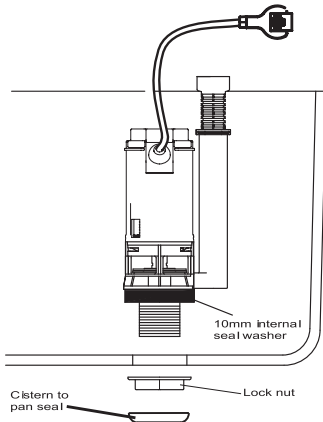

Position the Valve inside the tank ensuring the 10mm internal seal washer is on the thread shank first.

Push down on the valve body and tighten up lock nut.

If close coupled carefully refit cistern to pan seal (**not supplied**) onto threaded end of flush valve.

Reconnect cistern to pan or pipework if low level.

**Note:** If a close coupling plate is required for your cistern, this should be installed on the threaded shank **before** the lock nut.

**IMPORTANT:** DO NOT use plumber's putty to seal this fitting.

For more information in the U.K. contact:

Fluidmaster UK  
Twyford Road  
Rotherwas, Hereford, HR2 6JR  
Tel: 01432 357331  
Fax: 01432 264014  
E-MAIL: [salesuk@fluidmaster.com](mailto:salesuk@fluidmaster.com)  
WEB: [www.fluidmasterUK.com](http://www.fluidmasterUK.com)

2. Select from one of the following 3 options, the correct mounting method for your cistern and follow the instructions.

#### \*\* IMPORTANT NOTICE \*\*

**The plastic nut & lever assembly thread have been designed with a reverse thread (left hand) to prevent loosening during operation.**

#### Application A (Ceramic cisterns with small lever hole)

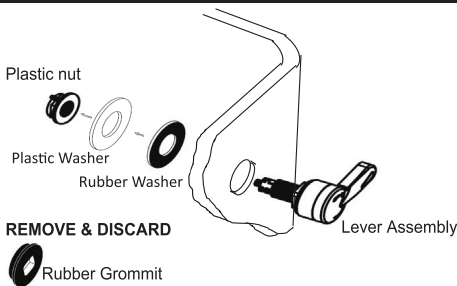

#### Application B (Ceramic cisterns with large lever hole)

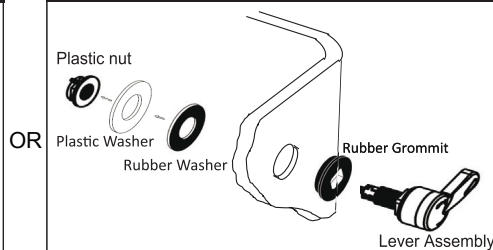

#### Application C (Thin walled plastic cisterns)

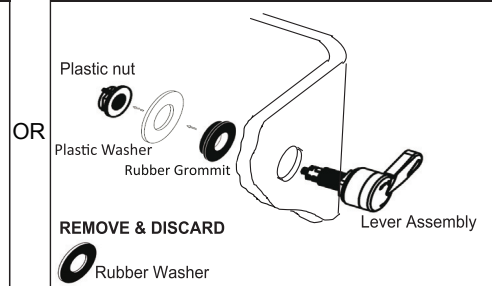

3.

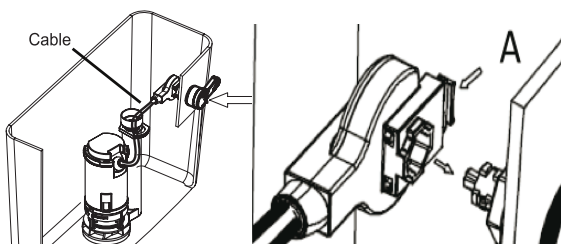

4. Ensure the cable runs smoothly & does not interfere with the workings of the valve.

5. To locate the lever into the junction box press clip (A) and insert, then release clip to lock.

**Note:** Pressing clip (A) will also allow release of lever from junction box.

#### Operation

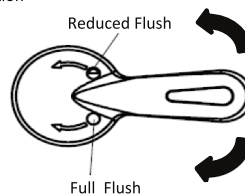

#### GUARANTEE:

This Fluidmaster product is guaranteed to be free from defective materials and workmanship for a period of one year. Units returned under guarantee to Fluidmaster USA or Fluidmaster UK will be replaced without charge. Always use quality Fluidmaster repair parts when maintaining your Fluidmaster products. Fluidmaster shall not be responsible or liable for any damages caused by products used in Fluidmaster valves that were not manufactured by Fluidmaster, Inc.

#### WARNING:

Fluidmaster, Inc. Shall not be liable for incidental or consequential damages, including costs of installation, water damage, personal injury or for any damages resulting from abuse or misuse of the product, from overtightening or from failure to install or maintain this plumbing product in accordance with the written instructions, including use of non-Fluidmaster parts. Do not use in-tank drop-in toilet bowl cleaners containing bleach or chlorine. Use of such products will result in damage to tank components and may cause flooding and property damage. Use of such products will void this warranty.

**WRAS**  
APPROVED  
PRODUCT

We pursue a policy of continuing improvement in design & performance of our products. The right is therefore reserved to vary specification without notice.

Illustration may not reflect item as supplied.