



SPEAR & JACKSON

High Performance Filters For Commercial & Industrial Heating Systems



**WITH
AUTOMATIC
AIR VENT**
FOR EXTRA CORROSION
PROTECTION



BoilerMag[®]
Dual Flow System Filter

www.boilermag.com

HEATING & COOLING SYSTEM PROTECTION

Maintaining system efficiency and reliability in larger properties is a major challenge for businesses, contractors, facilities managers and public organisations.



All heating systems are at risk from magnetite (sludge) which forms when air and water reacts with ferrous components. Left unchecked this can seriously **reduce energy efficiency** and cause premature failure of components, **resulting in high maintenance costs**.



BoilerMag High Performance Filters

BoilerMag high performance filters have been carefully engineered to provide lasting protection for larger heating and cooling systems. Powerful magnetic circuits combined with optimised fluid flow dynamics ensure that virtually every particle of magnetite (sludge) is removed on the first pass through the filter, thereby improving efficiency and protecting system components.

Ideal for systems in:-

- Educational buildings
- Healthcare buildings
- Municipal buildings
- Apartment blocks
- Office buildings
- Retail premises
- Factories
- Hotels



A CHOICE OF FILTERS

The range includes the BoilerMagXL filter which is ideal for medium sized properties with 1½" connections, whilst the BoilerMagXT range is ideal for heavy duty industrial heating and cooling systems with 2" up to 12" connections.

Added Protection against Corrosion

In addition to providing protection against magnetite (sludge), BoilerMagXL and BoilerMagXT units are supplied with Automatic Air Vents.

Air is a catalyst and enables corrosion to develop in heating and cooling systems. It can be trapped in the system when commissioned or released naturally when cold water is heated. This can result in excessive noise, reduction in flow rates, reduced heat exchange and corrosion.



BoilerMag's Automatic Air Vent continually releases air without any manual intervention, significantly reducing the risk of the problems outlined above.



Full Flow Design – filters 100% of water on first pass

A full flow filter is fitted in-line within the main circulation, hence 100% of system water passes through on each pass. It is vital that magnetite is extracted immediately from the circulation before it reaches the boiler. The alternative side stream filter method allows magnetite (sludge) to circulate several times and may even never be captured.



FULL FLOW FILTRATION
A clean, energy efficient system

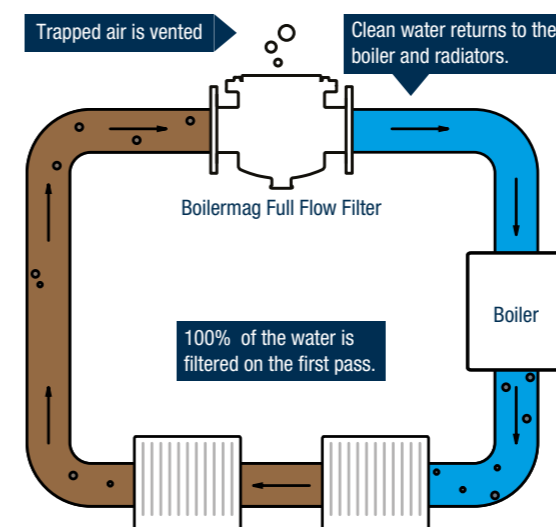

SIDE STREAM FILTRATION
A contaminated, inefficient system with a boiler prone to failure

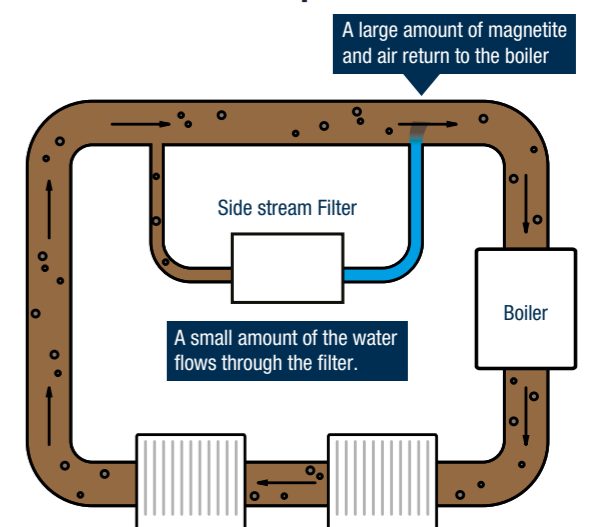

COST EFFECTIVE PROTECTION FOR MEDIUM SIZED PROPERTIES

BoilerMagXL is a high performance filter for medium sized commercial, retail or large residential properties. It is extremely cost effective for mid-range projects where a typical domestic filter is too small and an industrial filter too big or expensive.

Triple Protection

BoilerMagXL provides protection against 3 key areas that are commonly associated with heating and cooling systems, magnetite (sludge), scale and air.

- Integral mesh guard intercepts lime-scale and other non-magnetic debris
- High performance magnetic core which removes magnetite (sludge)
- Automatic Air Vent reduces the risk of air generated corrosion

Robust construction delivering excellent performance

- 10 year warranty
- No block feature
- Easy to service and clean
- Large collection capacity
- No consumable or replacement parts
- Dual flow action - excellent dirt removal rates
- Compact design – in comparison to large industrial filters
- Easy installation – fits standard 1½" BSP connections



GETTING TO KNOW YOUR BOILERMAG XL

We have utilised our patented magnetic technology and knowledge of fluid flow characteristics to produce an installer friendly filter which delivers outstanding performance.

- 1 Automatic Air Vent
- 2 Easy to remove lid and magnetic core
- 3 Compatible with 1½" BSP connections
- 4 Dual flow around the core ensures maximum exposure to the magnetic field giving maximised collection efficiency
- 5 Mesh guard – removes non-magnetic debris such as scale
- 6 Easy access drain plug
- 7 Patented magnetic core with “no block” feature
- 8 High intensity magnets attract contamination
- 9 Full stainless steel construction

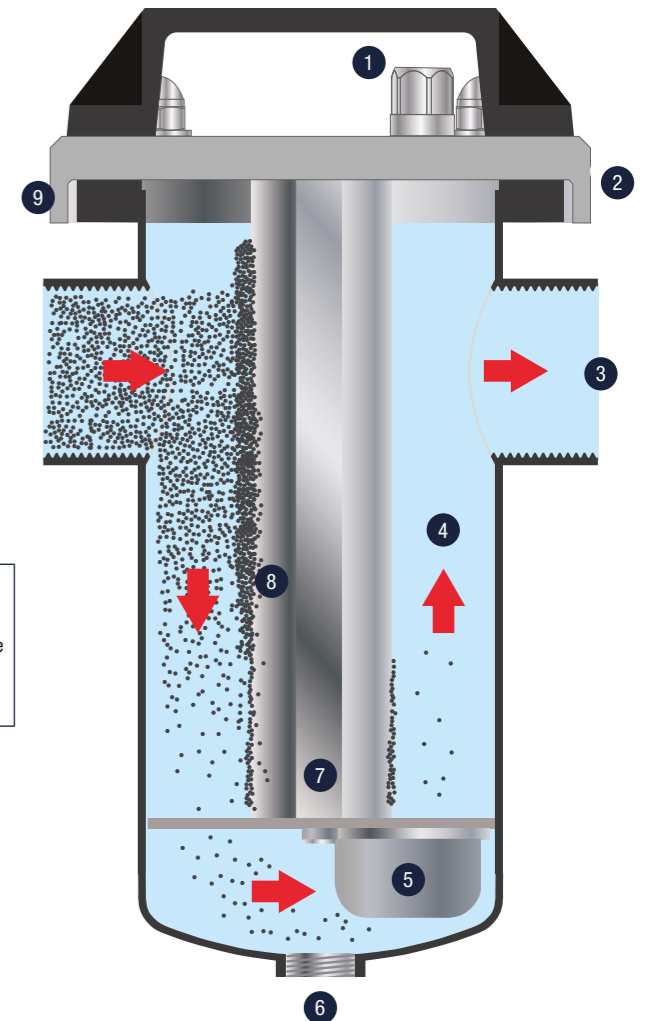
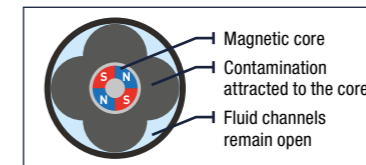

Where to install

For best results install on the return line of the heating system prior to the boiler

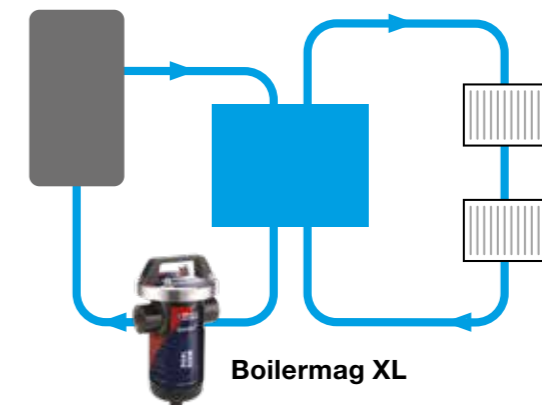

BOILERMAG XL TECHNICAL INFORMATION

- Weight: 5.6 kg
- Internal volume: 1.4 litres
- Contamination capacity: 1 kg
- Ports: 1½" BSP
- Warranty: 10 years
- Working pressure: 12 bar (if using the Automatic Air Vent option, the working pressure is 10 bar)
- Operating temperature: 5°C to 150°C (if using the Automatic Air Vent option, the maximum temperature is 110°C)

Material specifications

- Filter body: 304 stainless steel
- Magnet housing: Stainless steel
- Magnet material: Rare earth neodymium
- O ring seal: Viton BS244
- Surface finish: Powder coated
- Fasteners: Lid 4 x M8 domed nuts
- Drain plug: ½" BSP

Pressure drop data

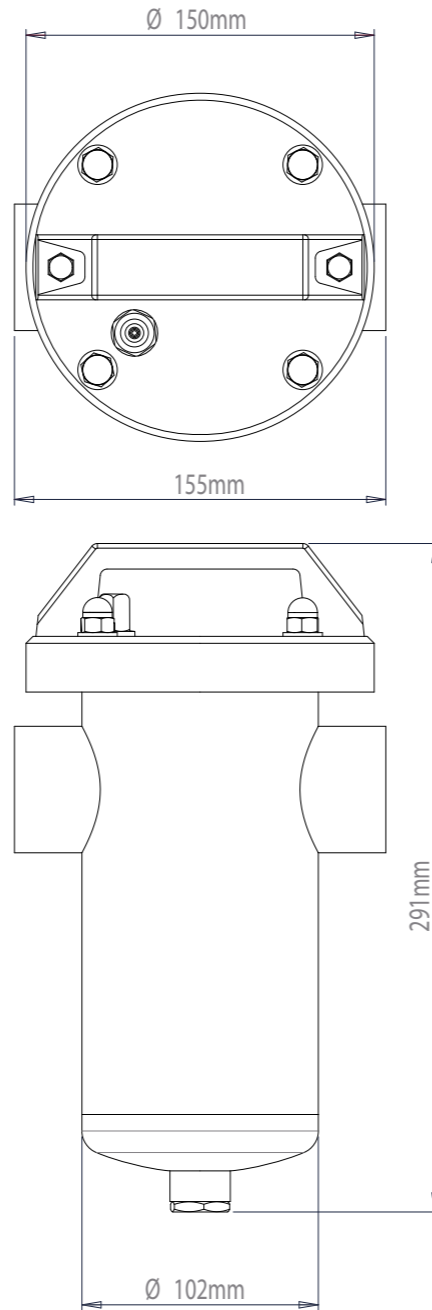
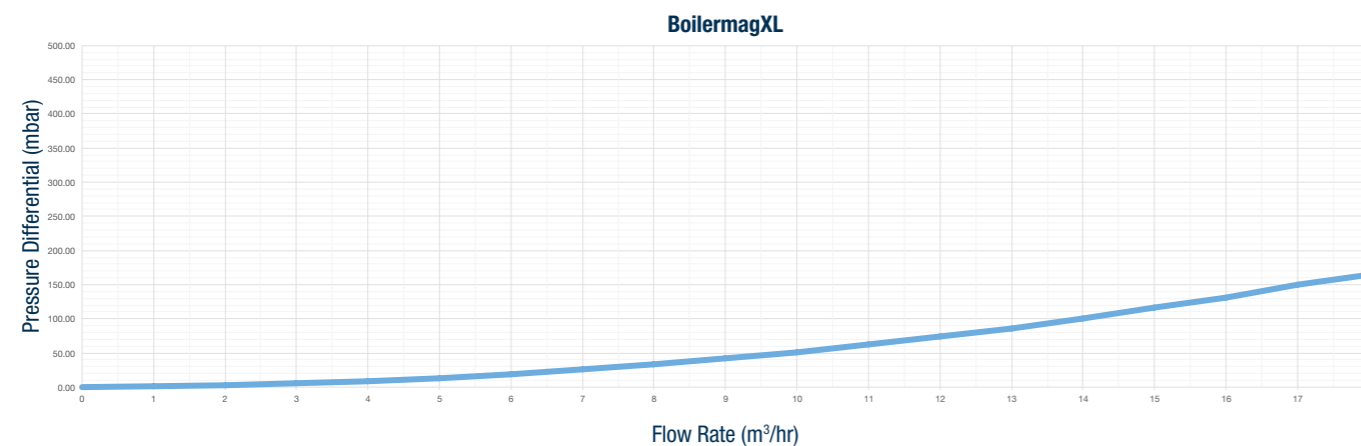

COST EFFECTIVE PROTECTION FOR LARGER SIZED PROJECTS

BoilermagXT is a range of high specification full flow filters for large industrial sized heating and cooling systems. BoilermagXT features a robust fabricated stainless steel construction which is ideal for the most demanding of applications.

With model sizes compatible for 2" up to 12" port sizes and PN16 flanges, BoilermagXT easily handles the efficiency and reliability demands of large industrial heating and cooling systems.

It provides long lasting protection for system components such as heat exchangers, pumps, radiators and fan coil units.

- Easy installation – fits standard PN16 flanged connections
- Simple to service and clean – no need to disconnect
- Operating temperature up to 150°C*
- Operating pressure up to 12 bar**
- Flow rates up to 310m³/hr
- Full flow – filters 100% of fluid
- Minimal pressure reductions
- Huge dirt collection capacity
- No on-going running costs



Try our system
treatment chemicals

Full
stainless steel
construction
**BUILT TO
LAST!**



*If using the Automatic Air Vent option, the maximum temperature is 110°C

**If using the Automatic Air Vent option, the working pressure is 10 bar

GETTING TO KNOW YOUR BOILERMAG XT

At Spear & Jackson Group we design and build magnetic systems for large scale applications in the most demanding industries such as automotive and aviation. We are perfectly placed to manufacture filters which can handle the efficiency and reliability demands of large industrial heating systems.

- 1 Simple connection to standard flanged connections
- 2 Automatic Air Vent
- 3 Multiple high power Neodymium magnetic cores
- 4 Robust fabricated stainless steel body
- 5 Excellent flow dynamics (maximum collection, minimum pressure drop)
- 6 Easy access drain plug
- 7 Port sizes available up to 12"



Where to install BoilermagXT

BoilermagXT is typically installed on the return circuit as close to the boiler as possible. On larger systems we recommend installing a smaller unit elsewhere to give extra protection for radiators and pipework. For cooling systems the BoilermagXT should be installed on the return just before the chiller.

Install in a location with adequate access to withdraw the magnets during maintenance and servicing. Also allow access to the drain plug to connect a hose or hold a bucket during draining.

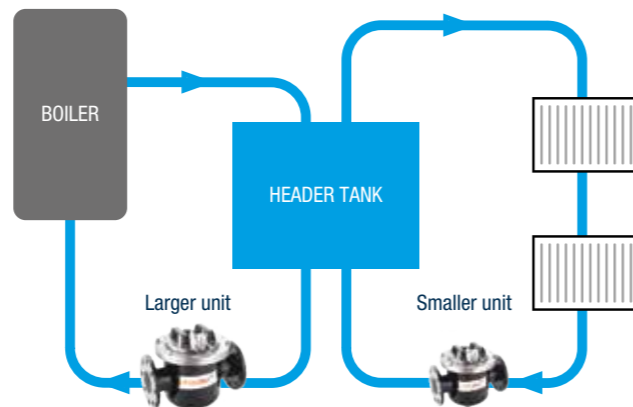

BOILERMAG XT TECHNICAL INFORMATION

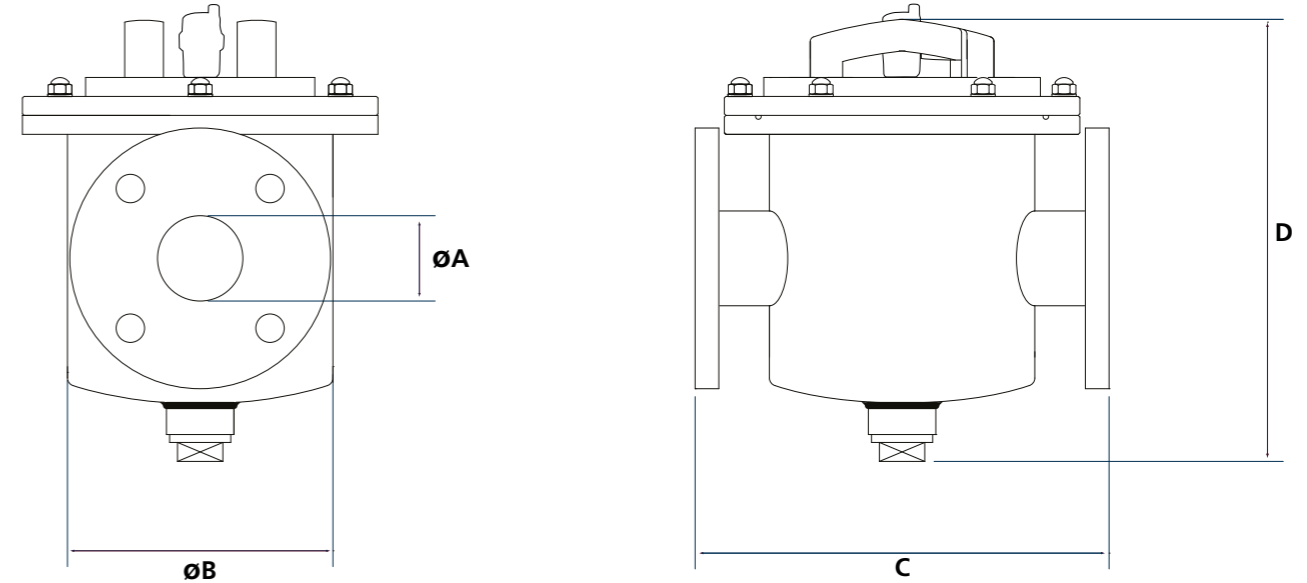

Part Number	Inlet / Outlet Diameter A	Filter Dia. B	Flange spacing C	Height D	No. magnetic rods	Flow rate cubic metres / hour	Flange type
BMXT150/2/AAV	2" / DN50	170mm	260mm	280mm	5	20	PN16
BMXT200/3/AAV	3" / DN80	220mm	360mm	335mm	7	55	PN16
BMXT200/4/AAV	4" / DN100	220mm	360mm	335mm	7	85	PN16
BMXT300/6/AAV	6" / DN150	325mm	470mm	420mm	9	110	PN16
BMXT300/8/AAV	8" / DN200	325mm	525mm	460mm	9	140	PN16
BMXT400/10/AAV	10" / DN250	406mm	760mm	600mm	16	220	PN16
BMXT400/12/AAV	12" / DN300	406mm	760mm	675mm	16	310	PN16

Before installing consult the product manual for maintenance clearance heights.

Usage: Full flow magnetic filter

Warranty: 10 years

Working pressure: 12 bar
(if using the Automatic Air Vent option, the working pressure is 10 bar)

Operating temperature: 5°C to 150°C
(if using the Automatic Air Vent option, the maximum temperature is 110°C)

Drain valve: 1¼"

Magnet performance: 9,000 Gauss
(reading taken on outer tube surface)

Material specifications

Filter body: 304 grade stainless steel
Magnet housing: 316 grade stainless steel
Magnet material: Rare earth neodymium iron boron
O ring seal: Viton BS244
Surface finish: External: Powder coated, Internal: Bead blasted

Special Designs

We can engineer BoilermagXT units to fit port sizes up to 20", with temperature resistance up to 250°C, operating pressures up to 50 bar and flow rates up to 900m³/hr. Please contact us to discuss any special requirements.

BOILERMAG XT PRESSURE DROP DATA

BoilermagXT is a full flow filter which has been designed to maximise contamination collection, but without significantly reducing the water pressure. The graphs below show the pressure drop levels at different flow rates.

2" BoilermagXT
BMXT150/2/AAV

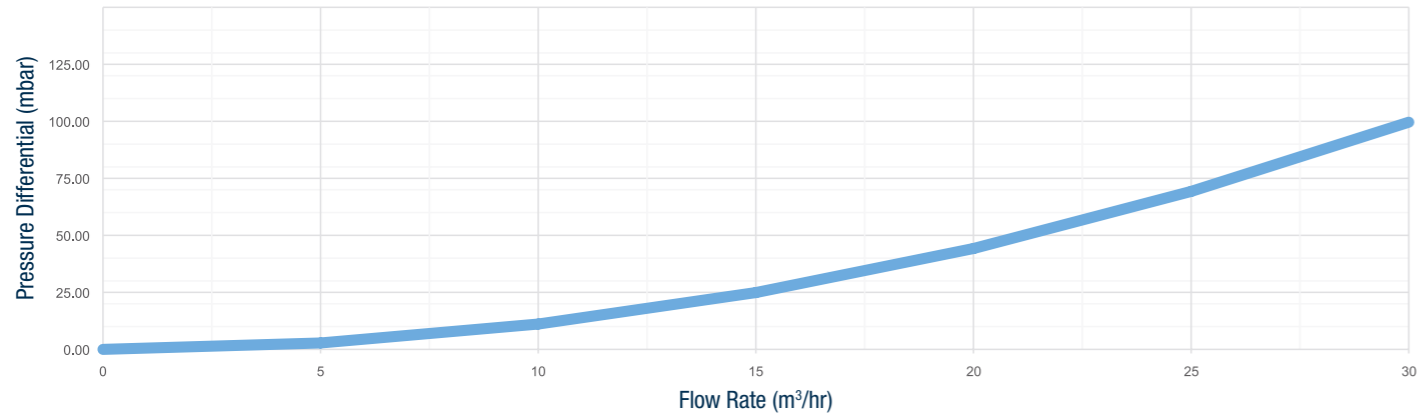

3" BoilermagXT
BMXT200/3/AAV

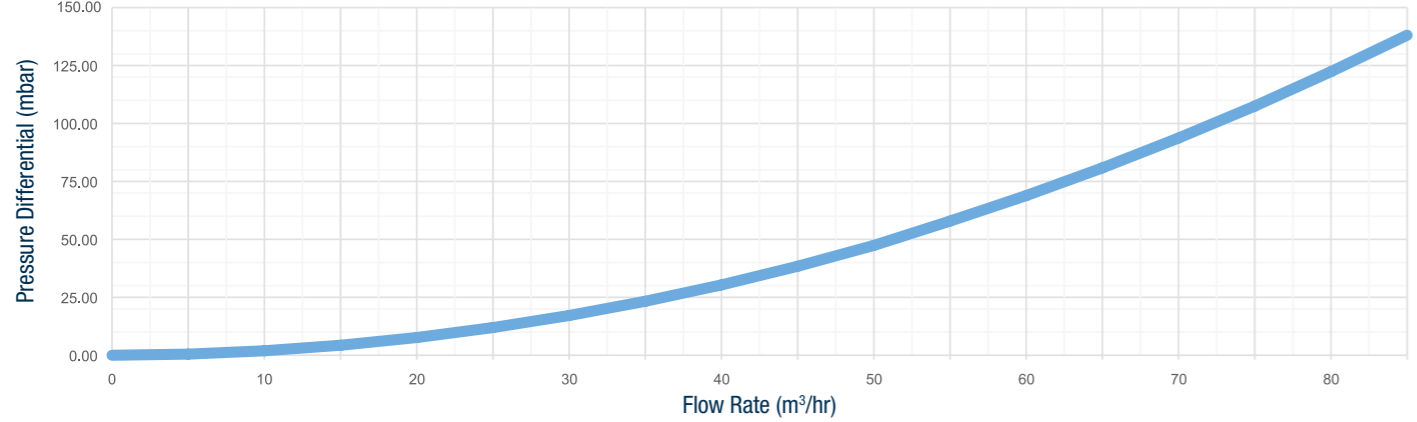

4" BoilermagXT
BMXT200/4/AAV

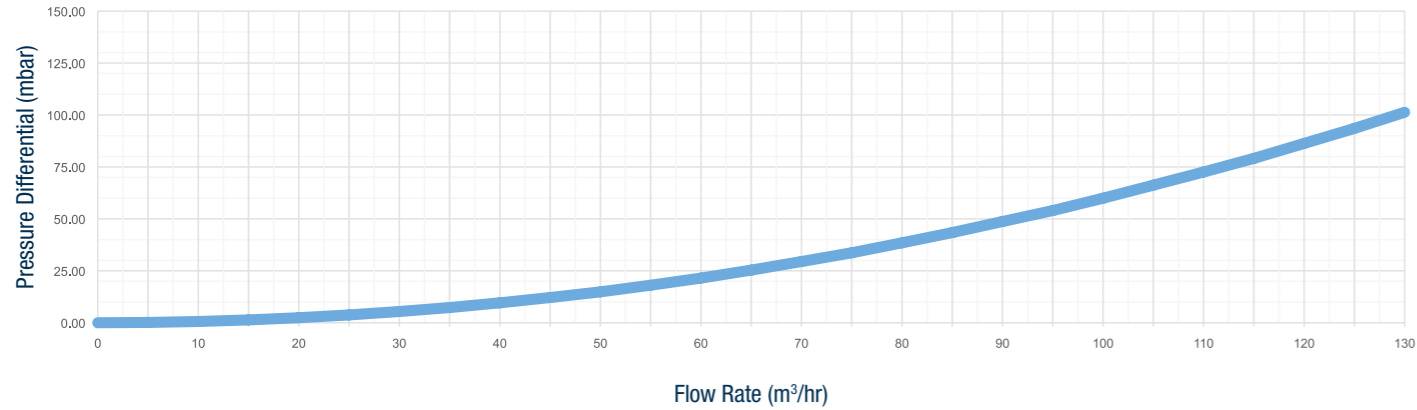

6" BoilermagXT
BMXT300/6/AAV

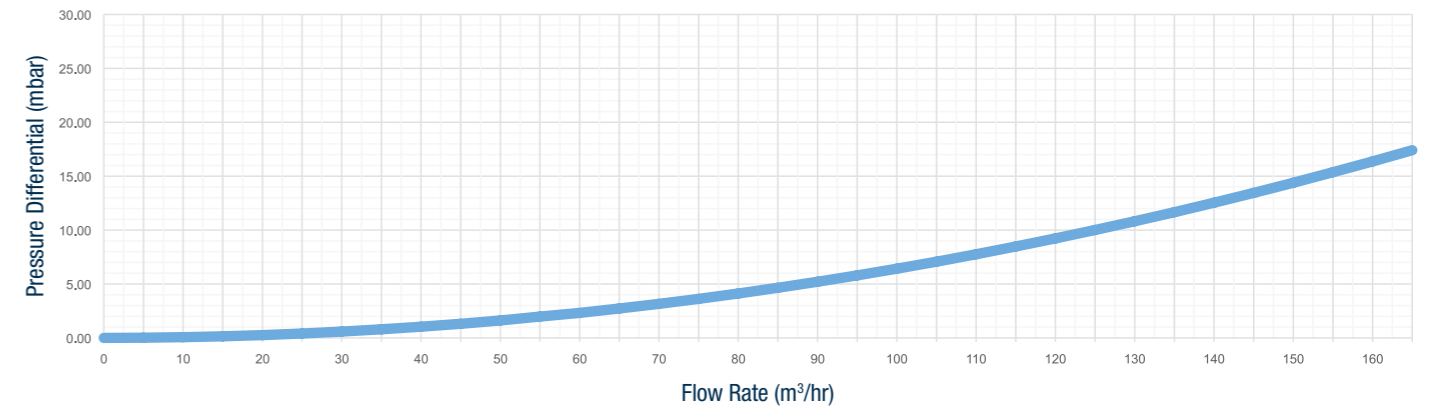

8" BoilermagXT
BMXT300/8/AAV

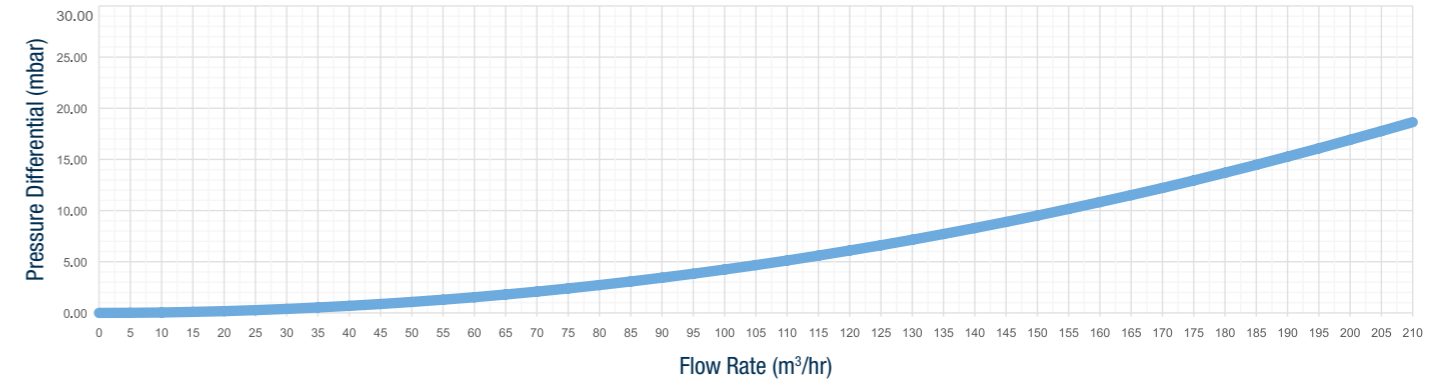

10" BoilermagXT
BMXT400/10/AAV

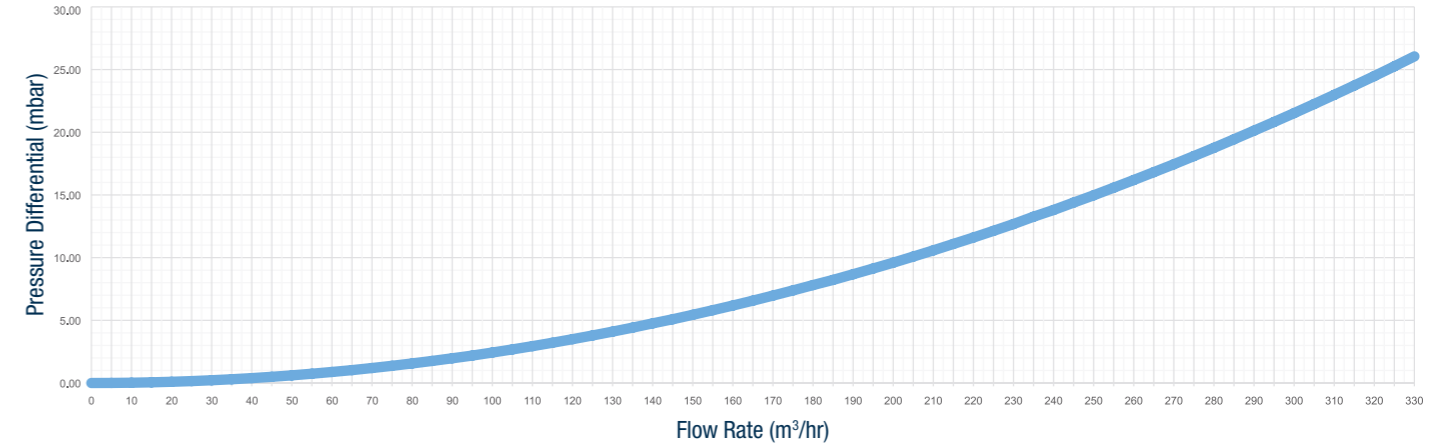

12" BoilermagXT
BMXT400/12/AAV

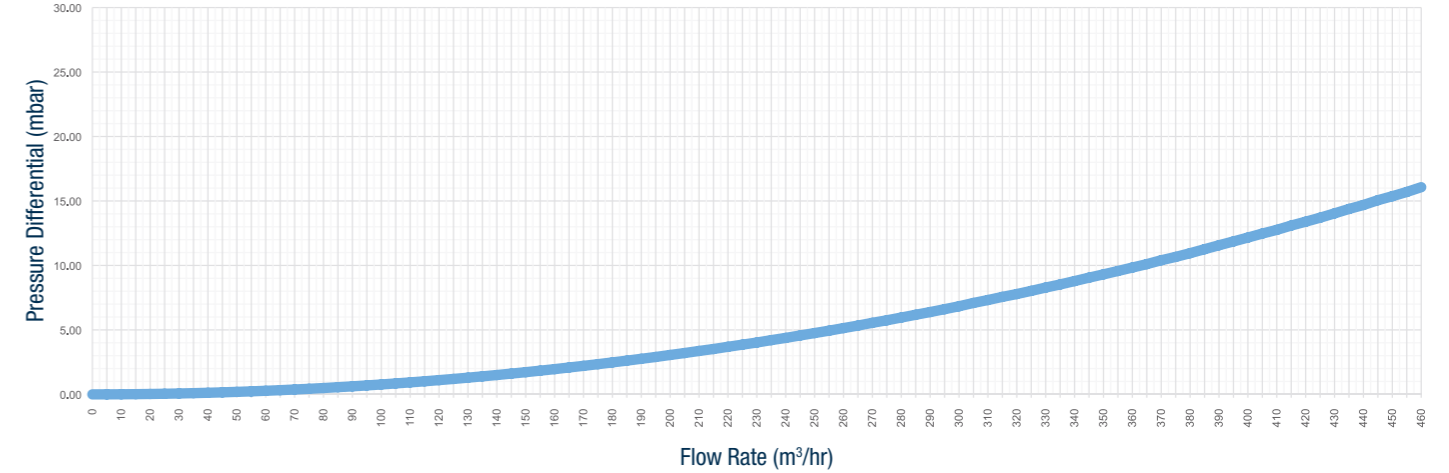

TRY OUR HEATING SYSTEM PROTECTION RANGE

In addition to commercial and industrial filters, the Boilermag range includes high performance products for the control of magnetite (sludge) and scale. The range features products for all property sizes, making it easy for installers and contractors to implement system treatment programmes.



Inhibitor & Cleaner



Boilermag Domestic Filter (22mm/28mm)



Testing Kits and Dosage Indicator Strips



Electrolytic Scale Reducers

Available from: